

CHAPTER TWO

SETS

Exercise Set 2.1

1. Set
2. Ellipsis
3. Description, Roster form, Set-builder notation
4. Finite
5. Infinite
6. Equal
7. Equivalent
8. Cardinal
9. Empty or null
10. $\{ \}, \emptyset$
11. Not well defined, “best” is interpreted differently by different people.
12. Not well defined, “most interesting” is interpreted differently by different people.
13. Well defined, the contents can be clearly determined.
14. Well defined, the contents can be clearly determined.
15. Well defined, the contents can be clearly determined.
16. Not well defined, “most interesting” is interpreted differently by different people.
17. Infinite, the number of elements in the set is not a natural number.
18. Finite, the number of elements in the set is a natural number.
19. Infinite, the number of elements in the set is not a natural number.
20. Infinite, the number of elements in the set is not a natural number.
21. Infinite, the number of elements in the set is not a natural number.
22. Finite, the number of elements in the set is a natural number.
23. $\{ \text{Hawaii} \}$
24. $\{ \text{January, June, July} \}$
25. $\{ 11, 12, 13, 14, \dots, 177 \}$
26. $C = \{ 4 \}$
27. $B = \{ 2, 4, 6, 8, \dots \}$
28. $\{ \}$ or \emptyset
29. $\{ \}$ or \emptyset
30. $\{ \text{Idaho, Oregon} \}$

31. $E = \{14, 15, 16, 17, \dots, 84\}$
32. $\{\text{Alaska, Hawaii}\}$
33. $\{\text{Bangkok, London, Paris, Singapore, New York}\}$
34. $\{\text{Hong Kong, Barcelona}\}$
35. $\{\}$ or \emptyset
36. $\{\text{Paris}\}$
37. $\{2012, 2013, 2014\}$
38. $\{2010, 2011\}$
39. $\{2011\}$
40. $\{\}$ or \emptyset
41. $B = \{x | x \in N \text{ and } 6 < x < 15\}$ or
 $B = \{x | x \in N \text{ and } 7 \leq x \leq 14\}$
42. $A = \{x | x \in N \text{ and } x < 10\}$ or
 $A = \{x | x \in N \text{ and } x \leq 9\}$
43. $C = \{x | x \in N \text{ and } x \text{ is a multiple of } 3\}$
44. $D = \{x | x \in N \text{ and } x \text{ is a multiple of } 5\}$
45. $E = \{x | x \in N \text{ and } x \text{ is odd}\}$
46. $A = \{x | x \text{ is Independence Day}\}$
47. $C = \{x | x \text{ is February}\}$
48. $F = \{x | x \in N \text{ and } 14 < x < 101\}$
or $F = \{x | x \in N \text{ and } 15 \leq x \leq 100\}$
49. Set A is the set of natural numbers less than or equal to 7.
50. Set D is the set of natural numbers that are multiples of 3.
51. Set V is the set of vowels in the English alphabet
52. Set S is the set of the seven dwarfs in *Snow White and the Seven Dwarfs*.
53. Set T is the set of species of trees.
54. Set E is the set of natural numbers greater than or equal to 4 and less than 11.
55. Set S is the set of seasons..
56. Set B is the set of members of the Beatles.
57. $\{\text{Facebook, Twitter, LinkedIn, Pinterest}\}$
58. $\{\text{Vk, Flickr, MySpace}\}$
59. $\{\text{Twitter, LinkedIn, Pinterest}\}$
60. $\{\text{Twitter}\}$
61. $\{2011, 2012, 2013, 2014\}$
62. $\{2005\}$
63. $\{2007, 2008, 2009, 2010\}$
64. $\{2013\}$
65. False; $\{e\}$ is a set, and not an element of the set.
66. True; b is an element of the set.
67. False; h is not an element of the set.
68. True; Mickey Mouse is an element of the set.
69. False; 3 is an element of the set.
70. False; the Amazon is a river in South America.
71. True; 9 is an odd natural number.
72. False; 2 is an even natural number.
73. $n(A) = 4$
74. $n(B) = 6$
75. $n(C) = 0$
76. $n(D) = 5$
77. Both; A and B contain exactly the same elements.
78. Equivalent; both sets contain the same number of elements, 3
79. Neither; the sets have a different number of elements.
80. Neither; not all cats are Siamese.

81. Equivalent; both sets contain the same number of elements, 4.
82. Equivalent; both sets contain the same number of elements, 50.
83. a) Set A is the set of natural numbers greater than 2. Set B is the set of all numbers greater than 2.
 b) Set A contains only natural numbers. Set B contains other types of numbers, including fractions and decimal numbers.
 c) $A = \{3, 4, 5, 6, \dots\}$
 d) No; because there are an infinite number of elements between any two elements in set B , we cannot write set B in roster form.
84. a) Set A is the set of natural numbers greater than 2 and less than or equal to 5. Set B is the set of all numbers greater than 2 and less than or equal to 5.
 b) Set A contains only natural numbers. Set B contains other types of numbers, including fractions and decimal numbers.
 c) $A = \{3, 4, 5\}$
 d) No; because there are an infinite number of elements between any two elements in set B , we cannot write set B in roster form.
85. Cardinal; 7 tells how many.
86. Ordinal; 25 tells the relative position of the chart.
87. Ordinal; sixteenth tells Lincoln's relative position.
88. Cardinal; 35 tells how many dollars she spent.
89. Answers will vary.
90. Answers will vary. Examples: The set of elephants that can fly. The set of dogs that can talk. The set of Books that have no pages.
91. Answers will vary.
92. Answers will vary. Here are some examples.
 a) The set of men. The set of actors. The set of people over 12 years old. The set of people with two legs. The set of people who have been in a movie.
 b) The set of all the people in the world.

Exercise Set 2.2

1. Subset
2. Proper
3. 2^n , where n is the number of elements in the set.
4. $2^n - 1$, where n is the number of elements in the set.
5. True; {circle} is a subset of {square, circle, triangle}.
6. True; {rain} is a subset of {rain, snow, sleet, hail}.
7. False; potato is not in the second set.
8. False; magazine is not in the second set.
9. True; {cheesecake, pie} is a proper subset of {pie, cookie, cheesecake, brownie}.
10. True; {elm, oak, pine} is a proper subset of {oak, pine, elm, maple}.
11. False; no subset is a proper subset of itself.
12. False; no set is a proper subset of itself.
13. True; spade is an element of {diamond, heart, spade, club}.
14. True; swimming is an element of {swimming, sailing, kayaking}.
15. False; {quarter} is a set, not an element.
16. False; { } is a set, not an element.

17. True; tiger is not an element of {zebra, giraffe, polar bear} .
18. True; the empty set is a subset of every set, including itself.
19. True; {chair} is a proper subset of {sofa, table, chair} .
20. True; {a, b, c} = {c, b, a} .
21. False; the set $\{\emptyset\}$ contains the element \emptyset .
22. True; $\{\}$ and \emptyset each represent the empty set.
23. False; the set $\{0\}$ contains the element 0 .
24. True; the empty set is a subset of every set, including itself.
25. False; 0 is a number and $\{\}$ is a set.
26. True; the elements of the set are themselves sets.
27. $B \subseteq A, B \subset A$
28. $A = B, A \subseteq B, B \subseteq A$
29. $A \subseteq B, A \subset B$
30. None
31. $B \subseteq A, B \subset A$
32. $B \subseteq A, B \subset A$
33. $A = B, A \subseteq B, B \subseteq A$
34. $B \subseteq A, B \subset A$
35. $\{\}$ is the only subset.
36. $\{\}, \{\emptyset\}$
37. $\{\}, \{\text{cow}\}, \{\text{horse}\}, \{\text{cow, horse}\}$
38. $\{\}, \{\text{steak}\}, \{\text{pork}\}, \{\text{chicken}\}, \{\text{steak, pork}\}, \{\text{steak, chicken}\}, \{\text{pork, chicken}\}, \{\text{steak, pork, chicken}\}$
39. a) $\{\}, \{a\}, \{b\}, \{c\}, \{d\}, \{a, b\}, \{a, c\}, \{a, d\}, \{b, c\}, \{b, d\}, \{c, d\}, \{a, b, c\}, \{a, b, d\}, \{a, c, d\}, \{b, c, d\}, \{a, b, c, d\}$
 b) All the sets in part (a) are proper subsets of A except $\{a, b, c, d\}$.
40. a) $2^9 = 2 \times 2 \times 2 \times 2 \times 2 \times 2 \times 2 \times 2 \times 2 = 512$ subsets
 b) $2^9 - 1 = 512 - 1 = 511$ proper subsets
41. False; A could be equal to B .
42. True; every proper subset is a subset.
43. True; every set is a subset of itself.
44. False; no set is a proper subset of itself.
45. True; \emptyset is a proper subset of every set except itself.
46. True; \emptyset is a subset of every set.
47. True; every set is a subset of the universal set.
48. False; a set cannot be a proper subset of itself.
49. True; \emptyset is a proper subset of every set except itself and $U \neq \emptyset$.
50. False; the only subset of \emptyset is itself and $U \neq \emptyset$.
51. True; \emptyset is a subset of every set.
52. False; U is not a subset of \emptyset .
53. The number of different variations is equal to the number of subsets of {cell phone holder, bluetooth radio, anchor lights, cupholders, depth guage, navigation lights, dinette table, battery charging system, ski mirror}, which is $2^9 = 2 \times 2 \times 2 \times 2 \times 2 \times 2 \times 2 \times 2 \times 2 = 512$.
54. The number of different variations of the house is equal to the number of subsets of {automatic pool cleaner, solar cover, waterfall, hot tub, fountain, slide, diving board} , which is $2^7 = 2 \times 2 \times 2 \times 2 \times 2 \times 2 \times 2 = 128$.

55. The number of options is equal to the number of subsets of
 { cucumbers, onions, tomatoes, carrots, green peppers, olives, mushrooms }, which is
 $2^7 = 2 \times 2 \times 2 \times 2 \times 2 \times 2 \times 2 = 128$
56. The number of different variations is equal to the number of subsets of
 {call waiting, call forwarding, caller identification, three-way calling, voice mail, fax line},
 which is $2^6 = 2 \times 2 \times 2 \times 2 \times 2 \times 2 = 64$.
57. $E = F$ since they are both subsets of each other.
58. If there is a one-to-one correspondence between boys and girls, then the sets are equivalent.
59. a) Yes.
 b) No, c is an element of set D .
 c) Yes, each element of $\{a, b\}$ is an element of set D .
60. a) Each person has 2 choices, namely yes or no. $2 \times 2 \times 2 \times 2 = 16$
 b) YYYN, YYYN, YNYN, YNNY, NYYY, YYNN, YNYN, YNNY, NYNY, NNYY, NYYN, YNNN,
 NYNN, NNYN, NNNY, NNNN
 c) 5 out of 16
61. A one element set has one proper subset, namely the empty set. A one element set has two subsets, namely
 itself and the empty set. One is one-half of two. Thus, the set must have one element.
62. Yes
 63. Yes
 64. No

Section 2.3

1. Complement
2. Union
3. Intersection
4. Difference
5. Cartesian
6. Disjoint
7. $m \times n$
8. Four
- 9.

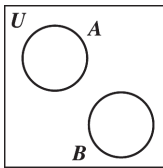

10.

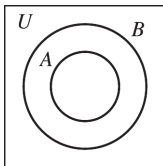

11.

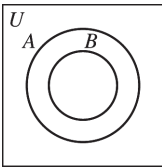

12.

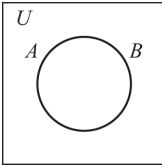

13.

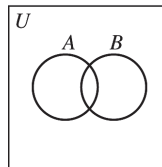

14.

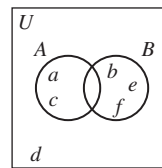

15.

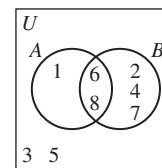

16.

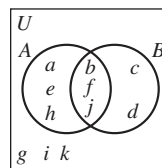

17.

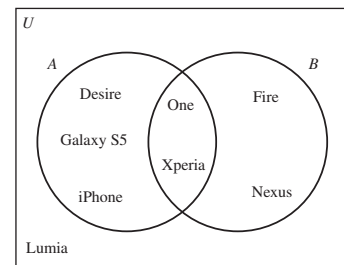

18.

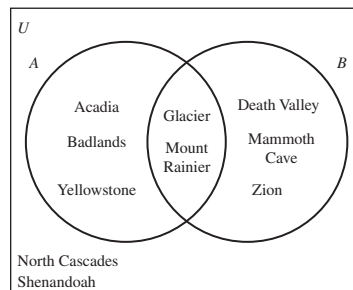

19.

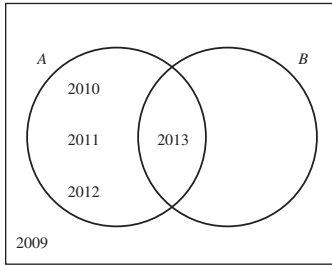

20.

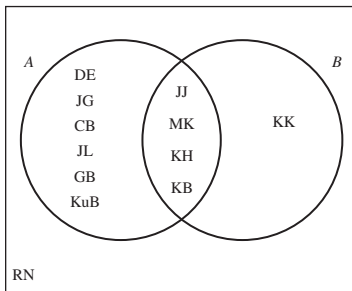

21. The set of retail stores in the United States that do not sell children's clothing
22. The set of animals in the United States' zoos that are not in the San Diego Zoo
23. The set of cities in the United States that do not have a professional sports team
24. The set of cities in the United States that do not have a symphony
25. The set of cities in the United States that have a professional sports team or a symphony
26. The set of cities in the United States that have a professional sports team and a symphony
27. The set of cities in the United States that have a professional sports team and do not have a symphony
28. The set of cities in the United States that have a professional sports team or do not have a symphony
29. The set of furniture stores in the U.S. that sell mattresses or leather furniture
30. The set of furniture stores in the U.S. that sell mattresses and outdoor furniture
31. The set of furniture stores in the U.S. that do not sell outdoor furniture and sell leather furniture
32. The set of furniture stores in the U.S. that sell mattresses, outdoor furniture, and leather furniture
33. The set of furniture stores in the U.S. that sell mattresses or outdoor furniture or leather furniture
34. The set of furniture stores in the U.S. that do not sell mattresses or do not sell leather furniture
35. $A = \{a, b, c, h, t, w\}$
36. $B = \{a, d, f, g, h, r, v\}$
37. $A \cap B = \{a, b, c, h, t, w\} \cap \{a, d, f, g, h, r, v\} = \{a, h\}$
38. $U = \{a, b, c, d, f, g, h, m, p, r, t, v, w, z\}$
39. $A \cup B = \{a, b, c, h, t, w\} \cup \{a, d, f, g, h, r, v\} = \{a, b, c, d, f, g, h, r, t, v, w\}$
40. $(A \cup B)'$: From #39, $A \cup B = \{w, b, c, t, a, h, f, r, d, g, v\}$.
 $(A \cup B)' = \{a, b, c, d, f, g, h, r, t, v, w\}' = \{m, p, z\}$
41. $A' \cap B' = \{d, f, g, m, p, r, v, z\} \cap \{b, c, m, p, t, w, z\} = \{m, p, z\}$
42. $(A \cap B)'$: From #37, $A \cap B = \{a, h\}$. $(A \cap B)' = \{a, h\}' = \{b, c, d, f, g, m, p, r, t, v, w, z\}$

43. $A - B = \{b, c, t, w\}$
44. $A - B' = \{a, h\}$
45. $A = \{1, 2, 7, 8, 9\}$
46. $B = \{2, 3, 5, 6, 9\}$
47. $U = \{1, 2, 3, 4, 5, 6, 7, 8, 9, 10, 11\}$
48. $A \cap B = \{1, 2, 7, 8, 9\} \cap \{2, 3, 5, 6, 9\} = \{2, 9\}$
49. $A' \cup B = \{3, 4, 5, 6, 10, 11\} \cup \{2, 3, 5, 6, 9\} = \{2, 3, 4, 5, 6, 9, 10, 11\}$
50. $A \cup B' = \{1, 2, 7, 8, 9\} \cup \{1, 4, 7, 8, 10, 11\} = \{1, 2, 4, 7, 8, 9, 10, 11\}$
51. $A' \cap B = \{3, 4, 5, 6, 10, 11\} \cap \{2, 3, 5, 6, 9\} = \{3, 5, 6\}$
52. $(A \cup B)' = \{4, 10, 11\}$
53. $A' - B = \{4, 10, 11\}$
54. $(A - B)' = \{2, 3, 4, 5, 6, 9, 10, 11\}$
55. $A \cup B = \{1, 2, 4, 5, 7\} \cup \{2, 3, 5, 6\} = \{1, 2, 3, 4, 5, 6, 7\}$
56. $A \cap B = \{1, 2, 4, 5, 7\} \cap \{2, 3, 5, 6\} = \{2, 5\}$
57. $(A \cup B)'$ From #55, $A \cup B = \{1, 2, 3, 4, 5, 6, 7\}$. $(A \cup B)' = \{1, 2, 3, 4, 5, 6, 7\}' = \{8\}$
58. $A' \cap B' = \{1, 2, 4, 5, 7\}' \cap \{2, 3, 5, 6\}' = \{3, 6, 8\} \cap \{1, 4, 7, 8\} = \{8\}$
59. $(A \cup B)' \cap B$: From #57, $(A \cup B)' = \{8\}$. $(A \cup B)' \cap B = \{8\} \cap \{2, 3, 5, 6\} = \{\}$
60. $(A \cup B) \cap (A \cup B)' = \{\}$ (The intersection of a set and its complement is always empty.)
61. $(B \cup A)' \cap (B' \cup A')$: From #57, $(A \cup B)' = (B \cup A)' = \{8\}$.
 $(B \cup A)' \cap (B' \cup A') = \{8\} \cap \left(\{2, 3, 5, 6\}' \cup \{1, 2, 4, 5, 7\}' \right) = \{8\} \cap (\{1, 4, 7, 8\} \cup \{3, 6, 8\})$
 $= \{8\} \cap \{1, 3, 4, 6, 7, 8\} = \{8\}$
62. $A' \cup (A \cap B)$: From #56, $A \cap B = \{2, 5\}$.
 $A' \cup (A \cap B) = \{1, 2, 4, 5, 7\}' \cup \{2, 5\} = \{3, 6, 8\} \cup \{2, 5\} = \{2, 3, 5, 6, 8\}$
63. $(A - B)' = \{2, 3, 5, 6, 8\}$
64. $A' - B' = \{3, 6\}$
- For exercises 65-74:
 $U = \{a, b, c, d, e, f, g, h, i, j, k\}$, $A = \{a, c, d, f, g, i\}$, $B = \{b, c, d, f, g\}$, $C = \{a, b, f, i, j\}$
65. $B \cup C = \{b, c, d, f, g\} \cup \{a, b, f, i, j\} = \{a, b, c, d, f, g, i, j\}$
66. $A \cap C = \{a, c, d, f, g, i\} \cap \{a, b, f, i, j\} = \{a, f, i\}$
67. $A' = \{b, e, h, j, k\}$, $B' = \{a, e, h, i, j, k\}$.
 $A' \cup B' = \{b, e, h, j, k\} \cup \{a, e, h, i, j, k\} = \{a, b, e, h, i, j, k\}$

68. $(A \cap C)'$: From #66, $A \cap C = \{a, f, i\}$. $(A \cap C)' = \{a, f, i\}' = \{b, c, d, e, g, h, j, k\}$
69. $(A \cap B) \cup C = (\{a, c, d, f, g, i\} \cap \{b, c, d, f, g\}) \cup \{a, b, f, i, j\} = \{c, d, f, g\} \cup \{a, b, f, i, j\}$
 $= \{a, b, c, d, f, g, i, j\}$
70. $A \cup (C \cap B)' = \{a, c, d, f, g, i\} \cup (\{a, b, f, i, j\} \cap \{b, c, d, f, g\})'$
 $= \{a, c, d, f, g, i\} \cup \{b, f\}'$
 $= \{a, c, d, f, g, i\} \cup \{a, c, d, e, g, h, i, j, k\} = \{a, c, d, e, f, g, h, i, j, k\}$
71. $(A' \cup C) \cup (A \cap B) = (\{a, c, d, f, g, i\}' \cup \{a, b, f, i, j\}) \cup (\{a, c, d, f, g, i\} \cap \{b, c, d, f, g\})$
 $= (\{b, e, h, j, k\} \cup \{a, b, f, i, j\}) \cup \{c, d, f, g\} = \{a, b, e, f, h, i, j, k\} \cup \{c, d, f, g\}$
 $= \{a, b, c, d, e, f, g, h, i, j, k\}$, or U
72. $(C \cap B) \cap (A' \cap B)$: From #70, $C \cap B = \{b, f\}$.
 $(C \cap B) \cap (A' \cap B) = \{b, f\} \cap (\{a, c, d, f, g, i\}' \cap \{b, c, d, f, g\}) = \{b, f\} \cap (\{b, e, h, j, k\} \cap \{b, c, d, f, g\})$
 $= \{b, f\} \cap \{b\} = \{b\}$
73. $A - B = \{a, i\}$, $(A - B)' = \{b, c, d, e, f, g, h, j, k\}$, $C = \{a, b, f, i, j\}$
 $(A - B)' - C = \{c, d, e, g, h, k\}$
74. $C - A = \{b, d, j\}$, $(C - A)' = \{a, c, e, f, g, h, i, k\}$, $B = \{b, c, d, f, g\}$
 $(C - A)' - B = \{a, e, h, i, k\}$
- For exercises 75-80: $A = \{1, 2, 3\}$ and $B = \{a, b\}$
75. $\{(1, a), (1, b), (2, a), (2, b), (3, a), (3, b)\}$
76. $\{(a, 1), (a, 2), (a, 3), (b, 1), (b, 2), (b, 3)\}$
77. No. The ordered pairs are not the same. For example $(1, a) \neq (a, 1)$
78. 6
79. 6
80. Yes
81. $A \cap B = \{1, 3, 5, 7, 9\} \cap \{2, 4, 6, 8\} = \{\}$
82. $A \cup B = \{1, 3, 5, 7, 9\} \cup \{2, 4, 6, 8\} = \{1, 2, 3, 4, 5, 6, 7, 8, 9\}$, or U
83. $(B \cup C)' = (\{2, 4, 6, 8\} \cup \{1, 2, 3, 4, 5\})' = \{1, 2, 3, 4, 5, 6, 8\}' = \{7, 9\}$
84. $A \cap C' = \{1, 3, 5, 7, 9\} \cap \{1, 2, 3, 4, 5\}' = \{1, 3, 5, 7, 9\} \cap \{6, 7, 8, 9\} = \{7, 9\}$
85. $A \cap B' = \{1, 3, 5, 7, 9\} \cap \{2, 4, 6, 8\}' = \{1, 3, 5, 7, 9\} \cap \{1, 3, 5, 7, 9\} = \{1, 3, 5, 7, 9\}$, or A
86. $(B \cap C)' = (\{2, 4, 6, 8\} \cap \{1, 2, 3, 4, 5\})' = \{2, 4\}' = \{1, 3, 5, 6, 7, 8, 9\}$

87. $(A \cup C) \cap B = (\{1, 3, 5, 7, 9\} \cup \{1, 2, 3, 4, 5\}) \cap \{2, 4, 6, 8\} = \{1, 2, 3, 4, 5, 7, 9\} \cap \{2, 4, 6, 8\} = \{2, 4\}$
88. $(A \cap B)' \cup C$: From #81, $A \cap B = \{ \}$.
 $(A \cap B)' \cup C = \{ \}' \cup \{1, 2, 3, 4, 5\} = \{1, 2, 3, 4, 5, 6, 7, 8, 9\} \cup \{1, 2, 3, 4, 5\} = \{1, 2, 3, 4, 5, 6, 7, 8, 9\}$, or U
89. $(A' \cup B') \cap C = \left(\{1, 3, 5, 7, 9\}' \cup \{2, 4, 6, 8\}' \right) \cap \{1, 2, 3, 4, 5\}$
 $= (\{2, 4, 6, 8\} \cup \{1, 3, 5, 7, 9\}) \cap \{1, 2, 3, 4, 5\} = \{1, 2, 3, 4, 5, 6, 7, 8, 9\} \cap \{1, 2, 3, 4, 5\} = \{1, 2, 3, 4, 5\}$, or C
90. $(A' \cap C) \cup (A \cap B)$: From #81, $A \cap B = \{ \}$.
 $(A' \cap C) \cup (A \cap B) = \left(\{1, 3, 5, 7, 9\}' \cap \{1, 2, 3, 4, 5\} \right) \cup \{ \} = (\{2, 4, 6, 8\} \cap \{1, 2, 3, 4, 5\}) \cup \{ \}$
 $= \{2, 4\} \cup \{ \} = \{2, 4\}$
91. A set and its complement will always be disjoint since the complement of a set is all of the elements in the universal set that are not in the set. Therefore, a set and its complement will have no elements in common. For example, if $U = \{1, 2, 3\}$, $A = \{1, 2\}$, and $A' = \{3\}$, then $A \cap A' = \{ \}$.
92. $n(A \cap B) = 0$ when A and B are disjoint sets. For example, if $U = \{1, 2, 3, 4, 5, 6\}$, $A = \{1, 3\}$, $B = \{2, 4\}$, then $A \cap B = \{ \}$. $n(A \cap B) = 0$
93. Let $A = \{ \text{customers who owned dogs} \}$ and $B = \{ \text{customers who owned cats} \}$.
 $n(A \cup B) = n(A) + n(B) - n(A \cap B) = 27 + 38 - 16 = 49$
94. Let $A = \{ \text{students who participated in intramurals} \}$ and $B = \{ \text{students who participated in student council} \}$.
 $n(A \cup B) = n(A) + n(B) - n(A \cap B)$
 $46 = n(A) + 30 - 4$
 $46 = n(A) + 26$
 $20 = n(A)$
95. a) $A \cup B = \{a, b, c, d\} \cup \{b, d, e, f, g, h\} = \{a, b, c, d, e, f, g, h\}$, $n(A \cup B) = 8$,
 $A \cap B = \{a, b, c, d\} \cap \{b, d, e, f, g, h\} = \{b, d\}$, $n(A \cap B) = 2$.
 $n(A) + n(B) - n(A \cap B) = 4 + 6 - 2 = 8$
Therefore, $n(A \cup B) = n(A) + n(B) - n(A \cap B)$.
- b) Answers will vary.
- c) Elements in the intersection of A and B are counted twice in $n(A) + n(B)$.
96. $A \cap B'$ defines Region I. $A \cap B$ defines Region II. $A' \cap B$ defines Region III.
 $A' \cap B'$ or $(A \cup B)'$ defines Region IV.
97. $A \cup B = \{1, 2, 3, 4, \dots\} \cup \{4, 8, 12, 16, \dots\} = \{1, 2, 3, 4, \dots\}$, or A
98. $A \cap B = \{1, 2, 3, 4, \dots\} \cap \{4, 8, 12, 16, \dots\} = \{4, 8, 12, 16, \dots\}$, or B
99. $B \cup C = \{4, 8, 12, 16, \dots\} \cup \{2, 4, 6, 8, \dots\} = \{2, 4, 6, 8, \dots\}$, or C
100. $B \cap C = \{4, 8, 12, 16, \dots\} \cap \{2, 4, 6, 8, \dots\} = \{4, 8, 12, 16, \dots\}$, or B
101. $A \cap C = \{1, 2, 3, 4, \dots\} \cap \{2, 4, 6, 8, \dots\} = \{2, 4, 6, 8, \dots\}$, or C

$$102. A' \cap C = \{1, 2, 3, 4, \dots\}' \cap \{2, 4, 6, 8, \dots\} = \{0\} \cap \{2, 4, 6, 8, \dots\} = \{ \}$$

$$103. (B \cup C)' \cup C: \text{From \#99, } B \cup C = C. (B \cup C)' \cup C = C' \cup C = \{2, 4, 6, 8, \dots\}' \cup \{2, 4, 6, 8, \dots\} \\ = \{0, 1, 2, 3, 4, \dots\}, \text{ or } U$$

$$104. (A \cap C) \cap B': \text{From \#101, } A \cap C = C. (A \cap C) \cap B' = C \cap B'. \\ \text{From \#111, } B' \cap C = C \cap B' = \{2, 6, 10, 14, 18, \dots\}$$

$$105. A \cap A' = \{ \}$$

$$106. A \cup A' = U$$

$$107. A \cup \emptyset = A$$

$$108. A \cap \emptyset = \emptyset$$

$$109. A' \cup U = U$$

$$110. A \cap U = A$$

$$111. \text{ If } A \cap B = B, \text{ then } B \subseteq A.$$

$$112. \text{ If } A \cup B = B, \text{ then } A \subseteq B.$$

$$113. \text{ If } A \cap B = \emptyset, \text{ then } A \text{ and } B \text{ are disjoint sets.}$$

$$114. \text{ If } A \cup B = \emptyset, \text{ then } A = \emptyset \text{ and } B = \emptyset.$$

Exercise Set 2.4

1. 8

2. a) V

b) VI

3. a) $A' \cap B'$

b) $A' \cup B'$

4. Deductive

5. $A' \cap B'$ is represented by regions V and VI. If $B \cap C$ contains 12 elements and region V contains 4 elements, then region VI contains $12 - 4 = 8$ elements.

6. $A \cap B$ is represented by regions II and V. If $A \cap B$ contains 9 elements and region V contains 4 elements, then region II contains $9 - 4 = 5$ elements.

7.

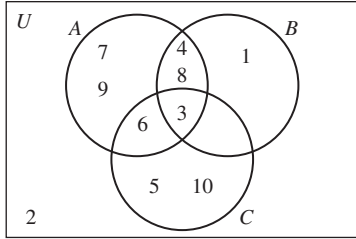

8.

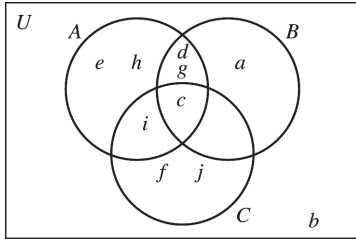

9.

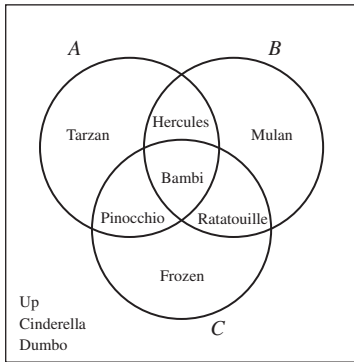

10.

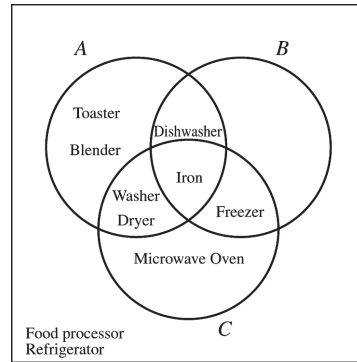

11.

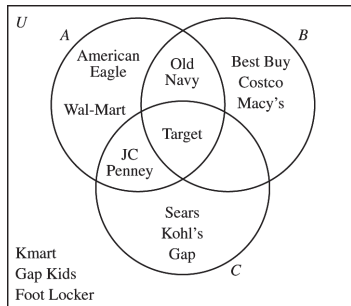

12.

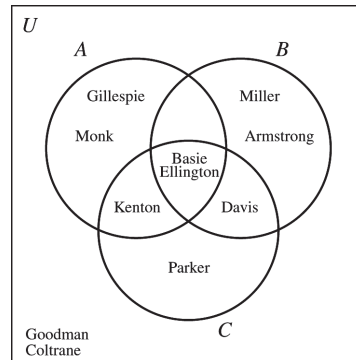

13.

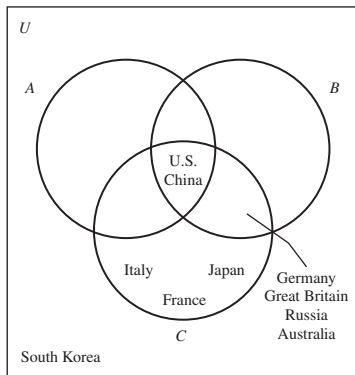

14.

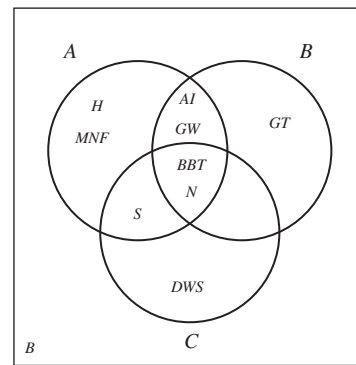

- 15. Canada, VI
- 17. Greece, V
- 19. Spain, VIII
- 21. VI
- 23. III
- 25. III
- 27. V
- 29. II

- 16. United States, VII
- 18. China, I
- 20. Turkey, II
- 22. VIII
- 24. IV
- 26. I
- 28. III
- 30. VIII

- 31. VII
- 33. I
- 35. VIII
- 37. VI
- 39. $A = \{1, 3, 4, 5, 9, 10\}$
- 41. $C = \{4, 5, 6, 8, 9, 11\}$
- 43. $A \cap B = \{3, 4, 5\}$
- 45. $(B \cap C)' = \{1, 2, 3, 7, 9, 10, 11, 12, 13, 14\}$
- 47. $(A \cup C)' = \{2, 7, 12, 13, 14\}$
- 49. $(A - B)' = \{2, 3, 4, 5, 6, 7, 8, 11, 12, 13, 14\}$

- 32. $VI(B \cap C)' = \{1, 2, 3, 7, 9, 10, 11, 12, 13, 14\}$
- 34. VII
- 36. V
- 38. III
- 40. $U = \{1, 2, 3, 4, 5, 6, 7, 8, 9, 10, 11, 12, 13, 14\}$
- 42. $B' = \{1, 2, 9, 10, 11, 13\}$
- 44. $A \cap C = \{4, 5, 9\}$
- 46. $A \cap B \cap C = \{4, 5\}$
- 48. $A \cap (B \cup C) = \{3, 4, 5, 9\}$
- 50. $A' - B = \{2, 11, 13\}$

51. $(A \cap B)'$ $A' \cup B'$

Set	Regions	Set	Regions
A	I, II	A	I, II
B	II, III	A'	III, IV
$A \cap B$	II	B	II, III
$(A \cap B)'$	I, III, IV	B'	I, IV
		$A' \cup B'$	I, III, IV

Both statements are represented by the same regions, I, III, IV, of the Venn diagram. Therefore,

$$(A \cap B)' = A' \cup B' \text{ for all sets } A \text{ and } B.$$

53. $A' \cup B'$ $A \cap B$

Set	Regions	Set	Regions
A	I, II	A	I, II
A'	III, IV	B	II, III
B	II, III	$A \cap B$	II
B'	I, IV		
$A' \cup B'$	I, III, IV		

Since the two statements are not represented by the same regions, it is not true that $A' \cup B' = A \cap B$ for all sets A and B .

55. $A' \cap B'$ $A \cup B'$

Set	Regions	Set	Regions
A	I, II	A	I, II
A'	III, IV	B	II, III
B	II, III	B'	I, IV
B'	I, IV	$A \cup B'$	I, II, IV
$A' \cap B'$	IV		

Since the two statements are not represented by the same regions, it is not true that $A' \cap B' = A \cup B'$ for all sets A and B .

52. $(A \cap B)'$ $A' \cup B$

Set	Regions	Set	Regions
A	I, II	A	I, II
B	II, III	A'	III, IV
$A \cap B$	II	B	II, III
$(A \cap B)'$	I, III, IV	$A' \cup B$	II, III, IV

Since the two statements are not represented by the same regions, it is not true that $(A \cap B)' = A' \cup B$ for all sets A and B .

54. $A' \cup B'$ $(A \cup B)'$

Set	Regions	Set	Regions
A	I, II	A	I, II
A'	III, IV	B	II, III
B	II, III	$(A \cup B)'$	I, II, IV
B'	I, IV		
$A' \cup B'$	I, III, IV		

Since the two statements are not represented by the same regions, it is not true that $A' \cup B' = (A \cup B)'$ for all sets A and B .

56. $A' \cap B'$ $A \cup B'$

Set	Regions	Set	Regions
A	I, II	A	I, II
A'	III, IV	B	II, III
B	II, III	B'	I, IV
$A' \cap B'$	III	$A \cup B'$	I, II, IV
$(A' \cap B)'$	I, II, IV		

Both statements are represented by the same regions, I, II, IV, of the Venn diagram. Therefore,

$$(A' \cap B)' = A \cup B' \text{ for all sets } A \text{ and } B.$$

57. $A \cap (B \cup C)$		$(A \cap B) \cup C$	
<u>Set</u>	<u>Regions</u>	<u>Set</u>	<u>Regions</u>
B	II, III, V, VI	A	I, II, IV, V
C	IV, V, VI, VII	B	II, III, V, VI
$B \cup C$	II, III, IV, V, VI, VII	$A \cap B$	II, V
A	I, II, IV, V	C	IV, V, VI, VII
$A \cap (B \cup C)$	II, IV, V	$(A \cap B) \cup C$	II, IV, V, VI, VII

Since the two statements are not represented by the same regions, it is not true that $A \cap (B \cup C) = (A \cap B) \cup C$ for all sets A, B , and C .

58. $A \cup (B \cap C)$		$(B \cap C) \cup A$	
<u>Set</u>	<u>Regions</u>	<u>Set</u>	<u>Regions</u>
B	II, III, V, VI	B	II, III, V, VI
C	IV, V, VI, VII	C	IV, V, VI, VII
$B \cap C$	V, VI	$B \cap C$	V, VI
A	I, II, IV, V	A	I, II, IV, V
$A \cup (B \cap C)$	I, II, IV, V, VI	$(B \cap C) \cup A$	I, II, IV, V, VI

Both statements are represented by the same regions, I, II, IV, V, VI, of the Venn diagram. Therefore, $A \cup (B \cap C) = (B \cap C) \cup A$ for all sets A, B , and C .

59. $A \cap (B \cup C)$		$(B \cup C) \cap A$	
<u>Set</u>	<u>Regions</u>	<u>Set</u>	<u>Regions</u>
B	II, III, V, VI	B	II, III, V, VI
C	IV, V, VI, VII	C	IV, V, VI, VII
$B \cup C$	II, III, IV, V, VI, VII	$B \cup C$	II, III, IV, V, VI, VII
A	I, II, IV, V	A	I, II, IV, V
$A \cap (B \cup C)$	II, IV, V	$(B \cup C) \cap A$	II, IV, V

Both statements are represented by the same regions, II, IV, V, of the Venn diagram. Therefore, $A \cap (B \cup C) = (B \cup C) \cap A$ for all sets A, B , and C .

60. $A \cup (B \cap C)'$		$A' \cap (B' \cup C)$	
<u>Set</u>	<u>Regions</u>	<u>Set</u>	<u>Regions</u>
B	II, III, V, VI	B'	I, IV, VII, VIII
C	IV, V, VI, VII	C	IV, V, VI, VII
$B \cap C$	V, VI	$B' \cup C$	I, IV, V, VI, VII, VIII
$(B \cap C)'$	I, II, III, IV, VII, VIII	A	I, II, IV, V
A	I, II, IV, V	A'	III, VI, VII, VIII
$A \cup (B \cap C)'$	I, II, III, IV, V, VII, VIII	$A' \cap (B' \cup C)$	VI, VII, VIII

Since the two statements are not represented by the same regions, it is not true that $A \cup (B \cap C)' = A' \cap (B' \cup C)$ for all sets A, B , and C .

61. $A \cap (B \cup C)$		$(A \cap B) \cup (A \cap C)$	
<u>Set</u>	<u>Regions</u>	<u>Set</u>	<u>Regions</u>
B	II, III, V, VI	A	I, II, IV, V
C	IV, V, VI, VII	B	II, III, V, VI
$B \cup C$	II, III, IV, V, VI, VII	$A \cap B$	II, V
A	I, II, IV, V	C	IV, V, VI, VII
$A \cap (B \cup C)$	II, IV, V	$A \cap C$	IV, V
		$(A \cap B) \cup (A \cap C)$	II, IV, V

Both statements are represented by the same regions, II, IV, V, of the Venn diagram.

Therefore, $A \cap (B \cup C) = (A \cap B) \cup (A \cap C)$ for all sets A, B , and C .

62. $A \cup (B \cap C)$		$(A \cup B) \cap (A \cup C)$	
<u>Set</u>	<u>Regions</u>	<u>Set</u>	<u>Regions</u>
B	II, III, V, VI	A	I, II, IV, V
C	IV, V, VI, VII	B	II, III, V, VI
$B \cap C$	V, VI	$A \cup B$	I, II, III, IV, V, VI
A	I, II, IV, V	C	IV, V, VI, VII
$A \cup (B \cap C)$	I, II, IV, V, VI	$A \cup C$	I, II, IV, V, VI, VII
		$(A \cup B) \cap (A \cup C)$	I, II, IV, V, VI

Both statements are represented by the same regions, I, II, IV, V, VI, of the Venn diagram.

Therefore, $A \cup (B \cap C) = (A \cup B) \cap (A \cup C)$ for all sets A, B , and C .

63. $(A \cup B) \cap (B \cup C)$		$B \cup (A \cap C)$	
<u>Set</u>	<u>Regions</u>	<u>Set</u>	<u>Regions</u>
A	I, II, IV, V	A	I, II, IV, V
B	II, III, V, VI	C	IV, V, VI, VII
$A \cup B$	I, II, III, IV, V, VI	$A \cap C$	IV, V
C	IV, V, VI, VII	B	II, III, V, VI
$B \cup C$	II, III, IV, V, VI, VII	$B \cup (A \cap C)$	II, III, IV, V, VI
$(A \cup B) \cap (B \cup C)$	II, III, IV, V, VI		

Both statements are represented by the same regions, II, III, IV, V, VI, of the Venn diagram.

Therefore, $(A \cup B) \cap (B \cup C) = B \cup (A \cap C)$ for all sets A, B , and C .

64. $(A \cup B)' \cap C$	$(A' \cup C) \cap (B' \cup C)$
<u>Set</u>	<u>Regions</u>
A	I, II, IV, V
B	II, III, V, VI
$A \cup B$	I, II, III, IV, V, VI
$(A \cup B)'$	VII, VIII
C	IV, V, VI, VII
$(A \cup B)' \cap C$	VII
<u>Set</u>	<u>Regions</u>
A	I, II, IV, V
A'	III, VI, VII, VIII
C	IV, V, VI, VII
$A' \cup C$	III, IV, V, VI, VII, VIII
B	II, III, V, VI
B'	I, IV, VII, VIII
$B' \cup C$	I, IV, V, VI, VII, VIII
$(A' \cup C) \cap (B' \cup C)$	IV, V, VI, VII, VIII

Since the two statements are not represented by the same regions, it is not true that $(A \cup B)' \cap C = (A' \cup C) \cap (B' \cup C)$ for all sets A, B , and C .

65. $(A \cup B)'$

66. $(A \cap B)'$

67. $(A \cup B) \cap C'$

68. $(A \cap B) \cup (B \cap C)$

69. a) $A \cap B = \{3, 6\}$, $(A \cap B)' = \{1, 2, 4, 5, 7, 8\}$

$A' = \{4, 5, 7, 8\}$, $B' = \{1, 2, 4, 5, 8\}$

$A' \cup B' = \{1, 2, 4, 5, 7, 8\}$

Both equal $\{1, 2, 4, 5, 7, 8\}$

b) Answers will vary.

70. a) $A \cup B = \{a, e, g, h, i, j\}$, $(A \cup B)' = \{b, c, d, f\}$

$A' = \{b, c, d, f\}$, $B' = \{b, c, d, e, f, h\}$

$A' \cap B' = \{b, c, d, f\}$

Both equal $\{b, c, d, f\}$

b) Answers will vary.

71.

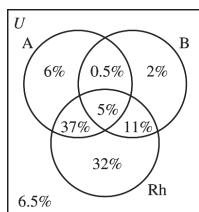

72.

<u>Region</u>	<u>Set</u>	<u>Region</u>	<u>Set</u>
I	$A \cap B' \cap C'$	V	$A \cap B \cap C$
II	$A \cap B \cap C'$	VI	$A' \cap B \cap C$
III	$A' \cap B \cap C'$	VII	$A' \cap B' \cap C$
IV	$A \cap B' \cap C$	VIII	$A' \cap B' \cap C'$

73. a) A : Office Building Construction Projects, B : Plumbing Projects, C : Budget Greater Than \$300,000

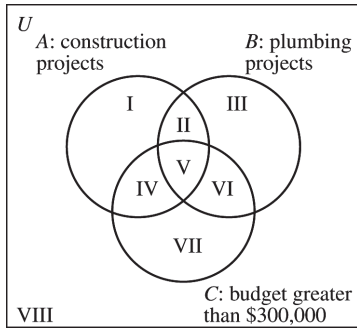

- b) Region V; $A \cap B \cap C$
- c) Region VI; $A' \cap B \cap C$
- d) Region I; $A \cap B' \cap C'$

74. $n(A \cup B \cup C) = n(A) + n(B) + n(C) - 2n(A \cap B \cap C) - n(A \cap B \cap C') - n(A \cap B' \cap C) - n(A' \cap B \cap C)$

75. a)

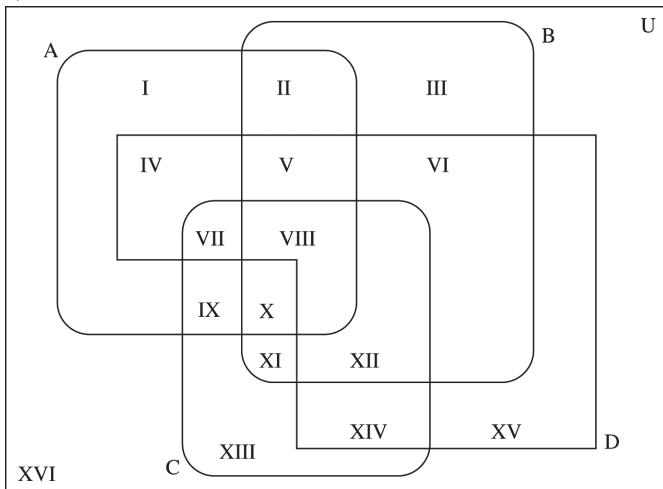

b)

<u>Region</u>	<u>Set</u>	<u>Region</u>	<u>Set</u>
I	$A \cap B' \cap C' \cap D'$	IX	$A \cap B' \cap C \cap D'$
II	$A \cap B \cap C' \cap D'$	X	$A \cap B \cap C \cap D'$
III	$A' \cap B \cap C' \cap D'$	XI	$A' \cap B \cap C \cap D'$
IV	$A \cap B' \cap C' \cap D$	XII	$A' \cap B \cap C \cap D$
V	$A \cap B \cap C' \cap D$	XIII	$A' \cap B' \cap C \cap D'$
VI	$A' \cap B \cap C' \cap D$	XIV	$A' \cap B' \cap C \cap D$
VII	$A \cap B' \cap C \cap D$	XV	$A' \cap B' \cap C' \cap D$
VIII	$A \cap B \cap C \cap D$	XVI	$A' \cap B' \cap C' \cap D'$

Exercise Set 2.5

1.

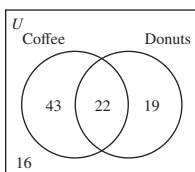

- a) 43
- b) 19
- c) $100 - (43 + 22 + 19)$, or 16

2.

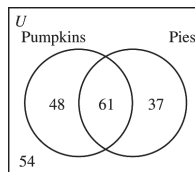

- a) 48
- b) 37
- c) $200 - (48 + 61 + 37)$, or 54

3.

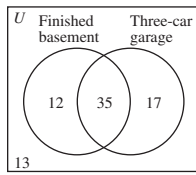

- a) 12 b) 17
 c) 64, the sum of the numbers in Regions I, II, III

4.

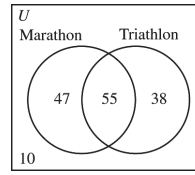

- a) 47 b) 38
 c) 140, the sum of the numbers in Regions I, II, III
 d) $150 - 140$, or 10.

5.

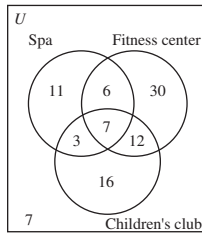

- a) 11 b) $11 + 30 + 16$, or 57
 c) $11 + 6 + 30 + 3 + 7 + 12 + 16$, or 85
 d) $3 + 6 + 12$, or 21
 e) 7

6.

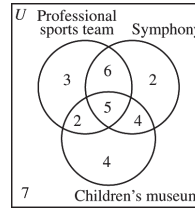

- a) 3 b) 6
 c) $3 + 2 + 6 + 5 + 2 + 4$, or 22
 d) $3 + 6 + 2$, or 11
 e) $2 + 6 + 4$, or 12

7.

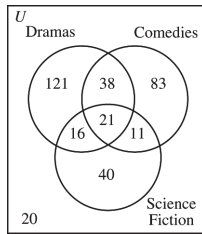

- a) 20 b) 121
 c) $121 + 83 + 40$, or 244
 d) $16 + 38 + 11$, or 65
 e) $350 - 20 - 40$, or 290

8.

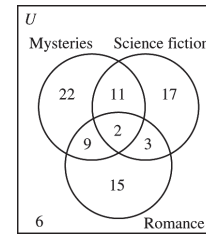

- a) 22 b) 11
 c) $85 - 15 - 6$, or 64
 d) $22 + 11 + 17$, or 50
 e) $9 + 11 + 3$, or 23

9.

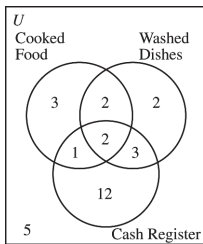

- a) 3 b) 12
 c) 3
 d) $12 + 3 + 2$, or 17 e) $1 + 2 + 3 + 2$, or 8

11.

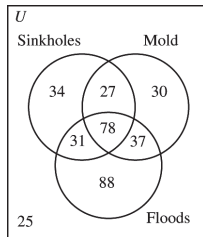

- a) $30 + 37$, or 67
 b) $350 - 25 - 88$, or 237
 c) 37 d) 25

13. The Venn diagram shows the number of cars driven by women is 37, the sum of the numbers in Regions II, IV, V. This exceeds the 35 women the agent claims to have surveyed.

10.

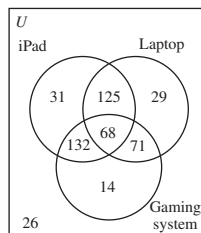

- a) 496, the sum of the numbers in all the regions
 b) 132 c) 29
 d) $132 + 125 + 71$, or 328
 e) $496 - 26$, or 470

12. No. The sum of the numbers in the Venn diagram is 99. Dennis claims he surveyed 100 people.

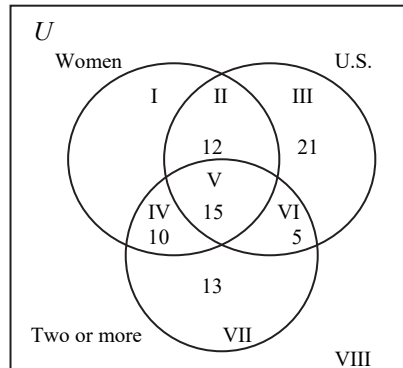
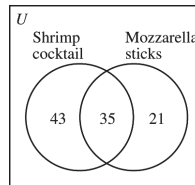

14. First fill in 15, 20 and 35 on the Venn diagram. Referring to the labels in the Venn diagram and the given information, we see that

$$a + c = 140$$

$$b + c = 125$$

$$a + b + c = 185 - 15 = 170$$

Adding the first two equations and subtracting the third from this sum gives $c = 125 + 140 - 170 = 95$. Then $a = 45$ and $b = 30$. Then $d = 210 - 45 - 95 - 20 = 50$. We now have labeled all the regions except the region outside the three circles, so the number of parks with at least one of the features is $15 + 45 + 20 + 30 + 95 + 50 + 35$, or 290. Thus the number with none of the features is $300 - 290$, or 10.

- a) 290
 b) 95
 c) 10
 d) $30 + 45 + 50$, or 125.

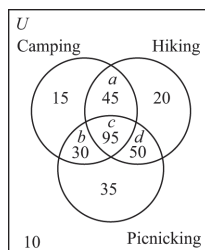

15. First fill in 125, 110, and 90 on the Venn diagram. Referring to the labels in the Venn diagram and the given information, we see that

$$a + c = 60$$

$$b + c = 50$$

$$a + b + c = 200 - 125 = 75$$

Adding the first two equations and subtracting the third from this sum gives $c = 60 + 50 - 75 = 35$. Then $a = 25$ and $b = 15$. Then $d = 180 - 110 - 25 - 35 = 10$. We now have labeled all the regions except the region outside the three circles, so the number of farmers growing at least one of the crops is $125 + 25 + 110 + 15 + 35 + 10 + 90$, or 410. Thus the number growing none of the crops is $500 - 410$, or 90.

- a) 410
 b) 35
 c) 90
 d) $15 + 25 + 10$, or 50

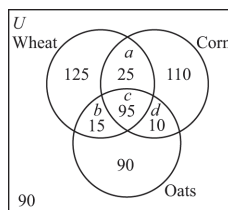

16. 16

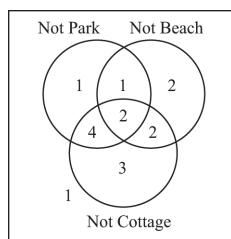

17. From the given information we can generate the Venn diagram. First fill in 4 for Region V. Then since the intersections in pairs all have 6 elements, we can fill in 2 for each of Regions II, IV, and VI. This already accounts for the 10 elements $A \cup B \cup C$, so the remaining 2 elements in U must be in Region VIII.

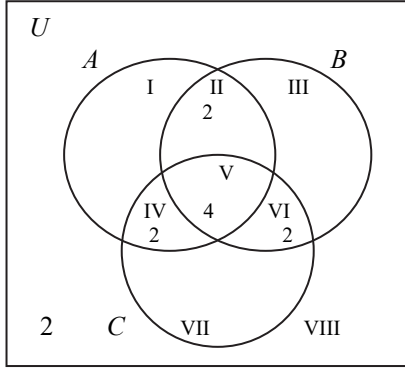

- a) 10, the sum of the numbers in Regions I, II, III, IV, V, VI
- b) 10, the sum of the numbers in Regions III, IV, V, VI, VIII
- c) 6, the sum of the numbers in Regions I, III, IV, VI, VIII

Exercise Set 2.6

1. Infinite

2. Countable

$$\begin{array}{ccccccc} \{2, 3, 4, 5, 6, \dots, n+1, \dots\} \\ \downarrow \downarrow \downarrow \downarrow \downarrow \quad \downarrow \\ \{3, 4, 5, 6, 7, \dots, n+2, \dots\} \end{array}$$

$$\begin{array}{ccccccc} \{20, 21, 22, 23, 24, \dots, n+19, \dots\} \\ \downarrow \downarrow \downarrow \downarrow \downarrow \quad \downarrow \\ \{21, 22, 23, 24, 25, \dots, n+20, \dots\} \end{array}$$

$$\begin{array}{ccccccc} \{3, 5, 7, 9, 11, \dots, 2n+1, \dots\} \\ \downarrow \downarrow \downarrow \downarrow \downarrow \quad \downarrow \\ \{5, 7, 9, 11, 13, \dots, 2n+3, \dots\} \end{array}$$

$$\begin{array}{ccccccc} \{10, 12, 14, 16, 18, \dots, 2n+8, \dots\} \\ \downarrow \downarrow \downarrow \downarrow \downarrow \quad \downarrow \\ \{12, 14, 16, 18, 20, \dots, 2n+10, \dots\} \end{array}$$

$$\begin{array}{ccccccc} \{5, 7, 9, 11, 13, \dots, 2n+3, \dots\} \\ \downarrow \downarrow \downarrow \downarrow \downarrow \quad \downarrow \\ \{9, 11, 13, 15, \dots, 2n+5, \dots\} \end{array}$$

$$\begin{array}{ccccccc} \{5, 9, 13, 17, 21, \dots, 4n+1, \dots\} \\ \downarrow \downarrow \downarrow \downarrow \downarrow \quad \downarrow \\ \{9, 13, 17, 21, 25, \dots, 4n+5, \dots\} \end{array}$$

$$\begin{array}{ccccccc} \left\{ \frac{1}{2}, \frac{1}{4}, \frac{1}{6}, \frac{1}{8}, \frac{1}{10}, \dots, \frac{1}{2n}, \dots \right\} \\ \downarrow \downarrow \downarrow \downarrow \quad \downarrow \\ \left\{ \frac{1}{4}, \frac{1}{6}, \frac{1}{8}, \frac{1}{10}, \dots, \frac{1}{2n+2}, \dots \right\} \end{array}$$

$$\begin{array}{ccccccc} \left\{ 1, \frac{1}{2}, \frac{1}{3}, \frac{1}{4}, \frac{1}{5}, \dots, \frac{1}{n}, \dots \right\} \\ \downarrow \downarrow \downarrow \downarrow \downarrow \quad \downarrow \\ \left\{ \frac{1}{2}, \frac{1}{3}, \frac{1}{4}, \frac{1}{5}, \frac{1}{6}, \dots, \frac{1}{n+1}, \dots \right\} \end{array}$$

11. $\left\{ \frac{4}{11}, \frac{5}{11}, \frac{6}{11}, \frac{7}{11}, \dots, \frac{n+3}{11}, \dots \right\}$
 $\downarrow \downarrow \downarrow \downarrow \quad \downarrow$
 $\left\{ \frac{5}{11}, \frac{6}{11}, \frac{7}{11}, \frac{8}{11}, \dots, \frac{n+4}{11}, \dots \right\}$
12. $\left\{ \frac{6}{13}, \frac{7}{13}, \frac{8}{13}, \frac{9}{13}, \frac{10}{13}, \dots, \frac{n+5}{13}, \dots \right\}$
 $\downarrow \downarrow \downarrow \downarrow \downarrow \quad \downarrow$
 $\left\{ \frac{7}{13}, \frac{8}{13}, \frac{9}{13}, \frac{10}{13}, \frac{11}{13}, \dots, \frac{n+6}{13}, \dots \right\}$
13. $\{1, 2, 3, 4, 5, \dots, n, \dots\}$
 $\downarrow \downarrow \downarrow \downarrow \downarrow \quad \downarrow$
 $\{2, 4, 6, 8, 10, \dots, 2n, \dots\}$
14. $\{1, 2, 3, 4, 5, \dots, n, \dots\}$
 $\downarrow \downarrow \downarrow \downarrow \downarrow \quad \downarrow$
 $\{30, 31, 32, 33, 34, \dots, n+29, \dots\}$
15. $\{1, 2, 3, 4, 5, \dots, n, \dots\}$
 $\downarrow \downarrow \downarrow \downarrow \downarrow \quad \downarrow$
 $\{3, 5, 7, 9, 11, \dots, 2n+1, \dots\}$
16. $\{1, 2, 3, 4, 5, \dots, n, \dots\}$
 $\downarrow \downarrow \downarrow \downarrow \downarrow \quad \downarrow$
 $\{4, 6, 8, 10, 12, \dots, 2n+2, \dots\}$
17. $\{1, 2, 3, 4, 5, \dots, n, \dots\}$
 $\downarrow \downarrow \downarrow \downarrow \downarrow \quad \downarrow$
 $\{2, 5, 8, 11, 14, \dots, 3n-1, \dots\}$
18. $\{1, 2, 3, 4, 5, \dots, n, \dots\}$
 $\downarrow \downarrow \downarrow \downarrow \downarrow \quad \downarrow$
 $\{7, 11, 15, 19, 23, \dots, 4n+3, \dots\}$
19. $\{1, 2, 3, 4, 5, \dots, n, \dots\}$
 $\downarrow \downarrow \downarrow \downarrow \downarrow \quad \downarrow$
 $\left\{ \frac{1}{3}, \frac{1}{6}, \frac{1}{9}, \frac{1}{12}, \frac{1}{15}, \dots, \frac{1}{3n}, \dots \right\}$
20. $\{1, 2, 3, 4, 5, \dots, n, \dots\}$
 $\downarrow \downarrow \downarrow \downarrow \downarrow \quad \downarrow$
 $\left\{ \frac{1}{2}, \frac{1}{4}, \frac{1}{6}, \frac{1}{8}, \frac{1}{10}, \dots, \frac{1}{2n}, \dots \right\}$
21. $\{1, 2, 3, 4, 7, \dots, n, \dots\}$
 $\downarrow \downarrow \downarrow \downarrow \downarrow \quad \downarrow$
 $\left\{ \frac{1}{3}, \frac{1}{4}, \frac{1}{5}, \frac{1}{6}, \frac{1}{7}, \dots, \frac{1}{n+2}, \dots \right\}$
22. $\{1, 2, 3, 4, 5, \dots, n, \dots\}$
 $\downarrow \downarrow \downarrow \downarrow \downarrow \quad \downarrow$
 $\left\{ \frac{1}{2}, \frac{2}{3}, \frac{3}{4}, \frac{4}{5}, \frac{5}{6}, \dots, \frac{n}{n+1}, \dots \right\}$
23. $\{1, 2, 3, 4, 5, \dots, n, \dots\}$
 $\downarrow \downarrow \downarrow \downarrow \downarrow \quad \downarrow$
 $\{1, 4, 9, 16, 25, \dots, n^2, \dots\}$
24. $\{1, 2, 3, 4, 5, \dots, n, \dots\}$
 $\downarrow \downarrow \downarrow \downarrow \downarrow \quad \downarrow$
 $\{2, 4, 8, 16, 32, \dots, 2^n, \dots\}$
25. $\{1, 2, 3, 4, 5, \dots, n, \dots\}$
 $\downarrow \downarrow \downarrow \downarrow \downarrow \quad \downarrow$
 $\{3, 9, 27, 81, 243, \dots, 3^n, \dots\}$
26. $\{1, 2, 3, 4, 5, \dots, n, \dots\}$
 $\downarrow \downarrow \downarrow \downarrow \downarrow \quad \downarrow$
 $\left\{ \frac{1}{3}, \frac{1}{6}, \frac{1}{12}, \frac{1}{24}, \frac{1}{48}, \dots, \frac{1}{3 \times 2^{n-1}}, \dots \right\}$
27. =
28. =
29. =
30. =
31. =
32. a) Answers will vary.
 b) No

Review Exercises

1. True
2. False; the word *best* makes the statement not well-defined.
3. True
4. False; no set is a proper subset of itself.
5. False; the elements 6, 12, 18, 24, ... are members of both sets.
6. True
7. False; the two sets do not contain exactly the same elements.
8. True
9. True
10. True
11. True
12. True
13. True
14. True
15. $A = \{7, 9, 11, 13, 15\}$
16. $B = \{\text{Colorado, Nebraska, Missouri, Oklahoma}\}$
17. $C = \{1, 2, 3, 4, \dots, 174\}$
18. $D = \{9, 10, 11, 12, \dots, 80\}$
19. $A = \{x | x \in N \text{ and } 50 < x < 150\}$ or
 $A = \{x | x \text{ in } N \text{ and } 51 \leq x \leq 149\}$
20. $B = \{x | x \in N \text{ and } x > 42\}$
21. $C = \{x | x \in N \text{ and } x < 7\}$
22. $D = \{x | x \in N \text{ and } 27 \leq x \leq 51\}$
23. A is the set of capital letters in the English alphabet from E through M, inclusive.
24. B is the set of U.S. coins with a value of less than one dollar.
25. C is the set of the first three lowercase letters in the English alphabet.
26. D is the set of numbers greater than or equal to 3 and less than 9.
27. $A \cap B = \{1, 3, 5, 7\} \cap \{3, 7, 9, 10\} = \{3, 7\}$
28. $A \cup B' = \{1, 3, 5, 7\} \cup \{3, 7, 9, 10\}' = \{1, 3, 5, 7\} \cup \{1, 2, 4, 5, 6, 8\} = \{1, 2, 3, 4, 5, 6, 7, 8\}$
29. $A' \cap B = \{1, 3, 5, 7\}' \cap \{3, 7, 9, 10\} = \{2, 4, 6, 8, 9, 10\} \cap \{3, 7, 9, 10\} = \{9, 10\}$
30. $(A \cup B)' \cup C = (\{1, 3, 5, 7\} \cup \{3, 7, 9, 10\})' \cup \{1, 7, 10\} = \{1, 3, 5, 7, 9, 10\}' \cup \{1, 7, 10\}$
 $= \{2, 4, 6, 8\} \cup \{1, 7, 10\} = \{1, 2, 4, 6, 7, 8, 10\}$
31. $A - B = \{1, 3, 5, 7\} - \{3, 7, 9, 10\} = \{1, 5\}$
32. $A - C' = \{1, 3, 5, 7\} - \{1, 7, 10\}' = \{1, 3, 5, 7\} - \{2, 3, 4, 5, 6, 8, 9\} = \{1, 7\}$
33. $\{(1, 1), (1, 7), (1, 10), (3, 1), (3, 7), (3, 10), (5, 1), (5, 7), (5, 10), (7, 1), (7, 7), (7, 10)\}$
34. $\{(3, 1), (3, 3), (3, 5), (3, 7), (7, 1), (7, 3), (7, 5), (7, 7), (9, 1), (9, 3), (9, 5), (9, 7), (10, 1), (10, 3), (10, 5), (10, 7)\}$
35. $2^4 = 2 \times 2 \times 2 \times 2 = 16$
36. $2^4 - 1 = (2 \times 2 \times 2 \times 2) - 1 = 16 - 1 = 15$

37.

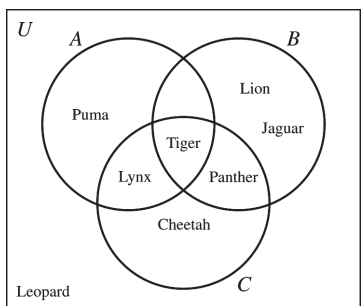

38. $A \cup C = \{b, c, d, e, f, h, k, l\}$

39. $A \cap B' = \{e, k\}$

40. $A \cup B \cup C = \{a, b, c, d, e, f, g, h, k, l\}$

41. $A \cap B \cap C = \{f\}$

42. $(A \cup B) \cap C = \{c, e, f\}$

43. $A - B' = \{d, f, l\}$

44. $(A' \cup B')'$ $A \cap B$

<u>Set</u>	<u>Regions</u>	<u>Set</u>	<u>Regions</u>
A	I, II	A	I, II
A'	III, IV	B	II, III
B	II, III	$A \cap B$	II
B'	I, IV		
$A' \cup B'$	I, III, IV		
$(A' \cup B')'$	II		

Both statements are represented by the same region, II, of the Venn diagram. Therefore, $(A' \cup B')' = A \cap B$ for all sets A and B .

45. $(A \cup B') \cup (A \cup C)'$ $A \cup (B \cap C)'$

<u>Set</u>	<u>Regions</u>	<u>Set</u>	<u>Regions</u>
A	I, II, IV, V	B	II, III, V, VI
B	II, III, V, VI	C	IV, V, VI, VII
B'	I, IV, VII, VIII	$B \cap C$	V, VI
$A \cup B'$	I, II, IV, V, VII, VIII	$(B \cap C)'$	I, II, III, IV, VII, VIII
C	IV, V, VI, VII	A	I, II, IV, V
C'	I, II, III, VIII	$A \cup (B \cap C)'$	I, II, III, IV, V, VII, VIII
$A \cup C'$	I, II, III, IV, V, VIII		
$(A \cup B') \cup (A \cup C)'$	I, II, III, IV, V, VII, VIII		

Both statements are represented by the same regions, I, II, III, IV, V, VII, VIII, of the Venn diagram.

Therefore, $(A \cup B') \cup (A \cup C)' = A \cup (B \cap C)'$ for all sets A, B , and C .

- 46. II
- 48. I
- 50. IV
- 52. II
- 53. The company paid \$450 since the sum of the numbers in Regions I through IV is 450.

- 47. III
- 49. IV
- 51. II

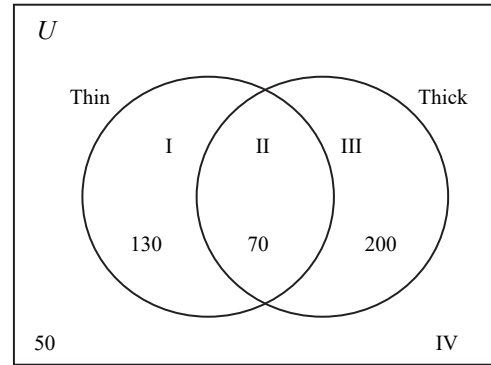

- 54. a) 131, the sum of the numbers in Regions I through VIII
- b) 32, Region I
- c) 10, Region II
- d) 65, the sum of the numbers in Regions I, IV, VII

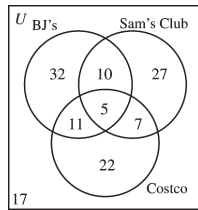

- 55. a) 128, Region I
- b) 264, the sum of the numbers in Regions I, III, VII
- c) 40, Region II
- d) 168, the sum of the numbers in Regions III, VI
- e) 99, the sum of the numbers in Regions II, IV, VI

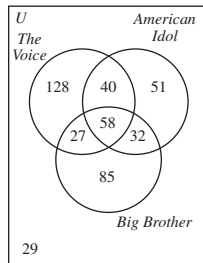

56. $\{2, 4, 6, 8, 10, \dots, 2n, \dots\}$
 $\downarrow \downarrow \downarrow \downarrow \downarrow \downarrow$
 $\{4, 6, 8, 10, 12, \dots, 2n + 2, \dots\}$

57. $\{3, 5, 7, 9, 11, \dots, 2n + 1, \dots\}$
 $\downarrow \downarrow \downarrow \downarrow \downarrow \downarrow$
 $\{5, 7, 9, 11, 13, \dots, 2n + 3, \dots\}$

58. $\{1, 2, 3, 4, 5, \dots, n, \dots\}$
 $\downarrow \downarrow \downarrow \downarrow \downarrow \downarrow$
 $\{5, 8, 11, 14, 17, \dots, 3n + 2, \dots\}$

59. $\{1, 2, 3, 4, 5, \dots, n, \dots\}$
 $\downarrow \downarrow \downarrow \downarrow \downarrow \downarrow$
 $\{4, 9, 14, 19, 24, \dots, 5n - 1, \dots\}$

Chapter Test

- 1. True
- 2. False; the sets do not contain exactly the same elements.

3. True
4. False; the second set does not contain the element 7.
5. False; the set has $2^4 = 2 \times 2 \times 2 \times 2 = 16$ subsets.
6. True
7. False; for any set A , $A \cup A' = U$, not $\{ \}$.
8. True
9. $A = \{1, 2, 3, 4, 5, 6, 7, 8, 9, 10, 11\}$
10. Set A is the set of natural numbers less than 12.
11. $A \cap B = \{3, 5, 7, 9\} \cap \{7, 9, 11, 15\} = \{7, 9\}$
12. $A \cup C' = \{3, 5, 7, 9\} \cup \{3, 11, 15\}' = \{3, 5, 7, 9\} \cup \{1, 5, 7, 9, 13\} = \{1, 3, 5, 7, 9, 13\}$
13. $A \cap (B \cap C') = \{3, 5, 7, 9\} \cap (\{7, 9, 11, 15\} \cap \{1, 5, 7, 9, 13\}) = \{3, 5, 7, 9\} \cap \{7, 9\} = \{7, 9\}$
14. $n(A \cap B') = n(\{3, 5, 7, 9\} \cap \{7, 9, 11, 15\}') = n(\{3, 5, 7, 9\} \cap \{1, 3, 5, 15\}) = n(\{3, 5\}) = 2$
15. $A - B = \{3, 5, 7, 9\} - \{7, 9, 11, 15\} = \{3, 5\}$
16. $A \times C = \{(3, 3), (3, 11), (3, 15), (5, 3), (5, 11), (5, 15), (7, 3), (7, 11), (7, 15), (9, 3), (9, 11), (9, 15)\}$
- 17.

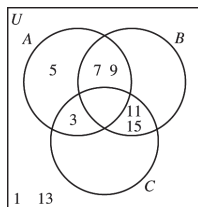

18.	$A \cap (B \cup C')$		$(A \cap B) \cup (A \cap C')$
<u>Set</u>	<u>Regions</u>	<u>Set</u>	<u>Regions</u>
B	II, III, V, VI	A	I, II, IV, V
C	IV, V, VI, VII	B	II, III, V, VI
C'	I, II, III, VIII	$A \cap B$	II, V
$B \cup C'$	I, II, III, V, VI, VIII	C	IV, V, VI, VII
A	I, II, IV, V	C'	I, II, III, VIII
$A \cap (B \cup C')$	I, II, V	$A \cap C'$	I, II
		$(A \cap B) \cup (A \cap C')$	I, II, V

Both statements are represented by the same regions, I, II, V, of the Venn diagram.

Therefore, $A \cap (B \cup C') = (A \cap B) \cup (A \cap C')$ for all sets A, B , and C .

19.

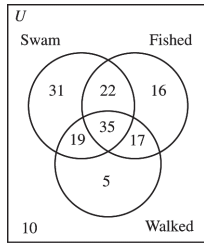

- a) 58, the sum of the numbers in Regions II, IV, VI
- b) 10, Region VIII
- c) 145, the sum of the numbers in all regions except VIII
- d) 22, Region II
- e) 69, the sum of the numbers in Regions I, II, III
- f) 16, Region III

20. $\{7, 8, 9, 10, 11, \dots, n + 6, \dots\}$
 $\downarrow \downarrow \downarrow \downarrow \downarrow \downarrow$
 $\{8, 9, 10, 11, 12, \dots, n + 7, \dots\}$

Survey of Mathematics with Applications 10th Edition Angel Solutions Manual

Full Download: <http://testbanklive.com/download/survey-of-mathematics-with-applications-10th-edition-angel-solutions-manual/>