

Unit 2 Solutions

Unit 2 Problem Solutions

2.1 See FLD p. 731 for solution.

2.2 (a) In both cases, if $X = 0$, the transmission is 0, and if $X = 1$, the transmission is 1.

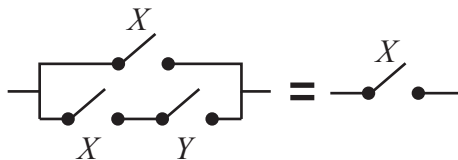

2.2 (b) In both cases, if $X = 0$, the transmission is YZ , and if $X = 1$, the transmission is 1.

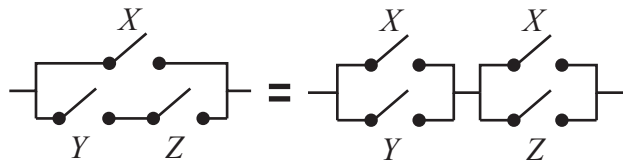

2.3 Answer is in FLD p. 731

2.4 (a) $F = [(A \cdot 1) + (A \cdot 1)] + E + BCD = A + E + BCD$

2.4 (b) $Y = (AB' + (AB + B)) B + A = (AB' + B) B + A = (A + B) B + A = AB + B + A = A + B$

2.5 (a) $(A + B)(C + B)(D' + B)(ACD' + E)$
 $= (AC + B)(D' + B)(ACD' + E)$ By Dist. Law
 $= (ACD' + B)(ACD' + E)$ By Dist. Law
 $= ACD' + BE$ By Dist. Law

2.5 (b) $(A' + B + C')(A' + C' + D)(B' + D')$
 $= (A' + C' + BD)(B' + D')$
 {By Distributive Law with $X = A' + C'$ }
 $= A'B' + B'C' + B'BD + A'D' + C'D' + BDD'$
 $= A'B' + A'D' + C'B' + C'D'$

2.6 (a) $AB + C'D' = (AB + C')(AB + D')$
 $= (A + C')(B + C')(A + D')(B + D')$

2.6 (b) $WX + WY'X + ZYX = X(W + WY' + ZY)$
 $= X(W + ZY)$ {By Absorption}
 $= X(W + Z)(W + Y)$

2.6 (c) $A'BC + EF + DEF' = A'BC + E(F + DF')$
 $= A'BC + E(F + D) = (A'BC + E)(A'BC + F + D)$
 $= (A' + E)(B + E)(C + E)(A' + F + D)$
 $(B + F + D)(C + F + D)$

2.6 (d) $XYZ + W'Z + XQ'Z = Z(XY + W' + XQ')$
 $= Z[W' + X(Y + Q')]$
 $= Z(W' + X)(W' + Y + Q')$ By Distributive Law

2.6 (e) $ACD' + C'D' + A'C = D'(AC + C') + A'C$
 $= D'(A + C) + A'C$ By Elimination Theorem
 $= (D' + A'C)(A + C' + A'C)$
 $= (D' + A')(D' + C)(A + C' + A')$
 By Distributive Law and Elimination Theorem
 $= (A' + D')(C + D')$

2.6 (f) $A + BC + DE$
 $= (A + BC + D)(A + BC + E)$
 $= (A + B + D)(A + C + D)(A + B + E)(A + C + E)$

2.7 (a) $(A + B + C + D)(A + B + C + E)(A + B + C + F)$
 $= A + B + C + DEF$
 Apply second Distributive Law twice

2.7 (b) $WXYZ + VXYZ + UXYZ = XYZ(W + V + U)$
 By first Distributive Law

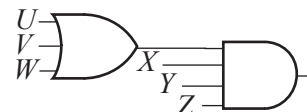
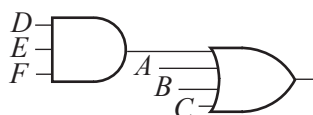

2.8 (a) $[(AB)' + C'D]' = AB(C'D)' = AB(C + D')$
 $= ABC + ABD'$

2.8 (b) $[A + B(C' + D)]' = A'(B(C' + D))'$
 $= A'(B' + (C' + D)') = A'(B' + CD')$
 $= A'B' + A'CD'$

2.8 (c) $((A + B')C')(A + B)(C + A)'$
 $= (A'B + C')(A + B)C'A' = (A'B + C')A'B'C'$
 $= A'BC'$

2.9 (a) $F = [(A + B)' + (A + (A + B)')] (A + (A + B)')'$
 $= (A + (A + B)')'$
 By Elimination Theorem with
 $X = (A + (A + B)')' = A'(A + B) = A'B$

2.9 (b) $G = \{[(R + S + T)' PT(R + S)]' T\}'$
 $= (R + S + T)' PT(R + S)' + T'$
 $= T' + (R'S'T) P(R'S)T = T' + PR'S'T = T'$

Unit 2 Solutions

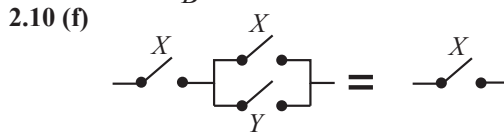
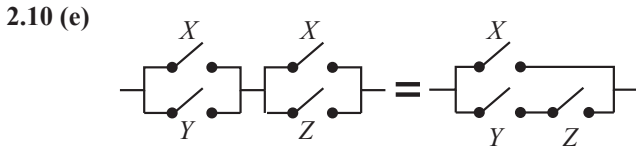
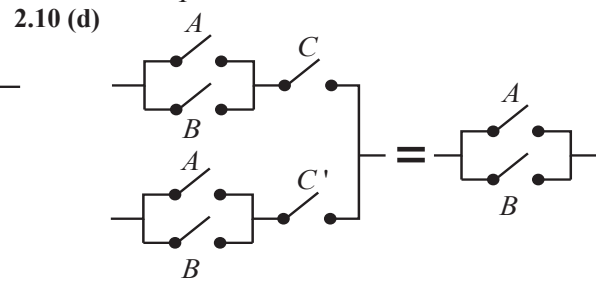
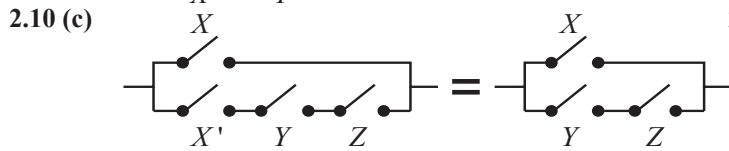
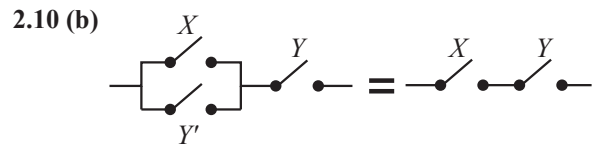
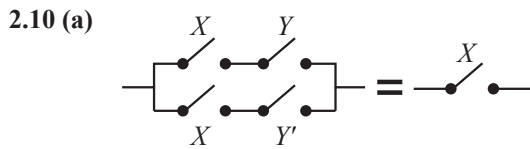

2.11 (a) $(A' + B' + C)(A' + B' + C)' = 0$ By Complementary Law

2.11 (b) $AB(C' + D) + B(C' + D) = B(C' + D)$ By Absorption

2.11 (c) $AB + (C' + D)(AB)' = AB + C' + D$ By Elimination Theorem

2.11 (d) $(A'BF + CD')(A'BF + CEG) = A'BF + CD'EG$ By Distributive Law

2.11 (e) $[AB' + (C + D)' + E'F](C + D) = AB'(C + D) + E'F(C + D)$ Distributive Law

2.11 (f) $A'(B + C)(D'E + F)' + (D'E + F) = A'(B + C) + D'E + F$ By Elimination

2.12 (a) $(X + Y'Z) + (X + Y'Z)' = 1$ By Complementary Law

2.12 (b) $[W + X'(Y + Z)][W' + X'(Y + Z)] = X'(Y + Z)$ By Uniting Theorem

2.12 (c) $(V'W + UX)'(UX + Y + Z + V'W) = (V'W + UX)'(Y + Z)$ By Elimination Theorem

2.12 (d) $(UV' + W'X)(UV' + W'X + Y'Z) = UV' + W'X$ By Absorption Theorem

2.12 (e) $(W' + X)(Y + Z') + (W' + X)'(Y + Z) = (Y + Z')$ By Uniting Theorem

2.12 (f) $(V' + U + W)[(W + X) + Y + UZ'] + [(W + X) + UZ' + Y] = (W + X) + UZ' + Y$ By Absorption

2.13 (a) $F_1 = A'A + B + (B + B) = 0 + B + B = B$

2.13 (b) $F_2 = A'A' + AB' = A' + AB' = A' + B'$

2.13 (c) $F_3 = [(AB + C)'D][(AB + C) + D] = (AB + C)'D(AB + C) + (AB + C)'D = (AB + C)'D$ By Absorption

2.13 (d) $Z = [(A + B)C]' + (A + B)CD = [(A + B)C]' + D$ By Elimination with $X = [(A + B)C]'$
 $= A'B' + C' + D'$

2.14 (a) $ACF(B + E + D)$

2.14 (b) $W + Y + Z + VUX$

2.15 (a) $f' = \{[A + (BCD)][(AD)' + B(C' + A)]\}' = [A + (BCD)]' + [(AD)' + B(C' + A)]' = A'(BCD)'' + (AD)''[B(C' + A)]' = A'BCD + AD[B' + (C' + A)] = A'BCD + AD[B' + C'A] = A'BCD + AD[B' + CA]$

2.15 (b) $f' = [AB'C + (A' + B + D)(ABD' + B')] = (AB'C)[(A' + B + D)(ABD' + B')] = (A' + B' + C)[(A' + B + D)' + (ABD')'B''] = (A' + B + C)[A''B'D' + (A' + B' + D'')B] = (A' + B + C)[AB'D' + (A' + B' + D)B]$

2.16 (a) $f^D = [A + (BCD)][(AD)' + B(C' + A)]^D = [A(B + C + D)] + [(A + D)(B + C'A)]$

2.16 (b) $f^D = [AB'C + (A' + B + D)(ABD' + B')]^D = (A + B' + C)[A'BD + (A + B + D')B']$

2.17 (a) $f = [(A' + B)C] + [A(B + C')] = A'C + B'C + AB + AC' = A'C + B'C + AB + AC' + BC = A'C + C + AB + AC' = C + AB + A = C + A$

2.17 (b) $f = A'C + B'C + AB + AC' = A + C$

2.17 (c) $f = (A' + B' + A)(A + C)(A' + B' + C' + B)(B + C + C') = (A + C)$

2.18 (a) product term, sum-of-products, product-of-sums)

Unit 2 Solutions

2.18 (b) sum-of-products

2.18 (d) sum term, sum-of-products, product-of-sums

2.19

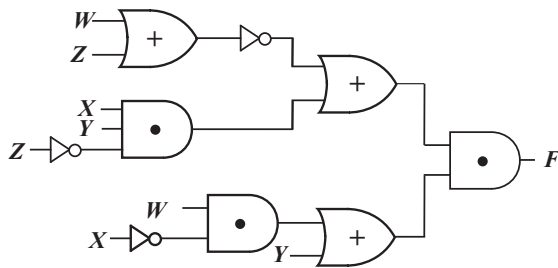

$$\begin{aligned} 2.20 \text{ (c)} \quad F &= D[(A' + B')C + AC'] \\ &= D(A' + B' + AC')(C + AC') \\ &= D(A' + B' + C')(C + A) \end{aligned}$$

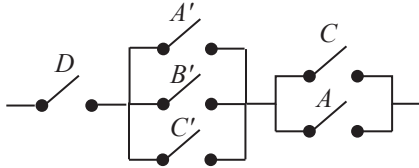

$$\begin{aligned} 2.22 \text{ (a)} \quad A'B' + A'CD + A'DE' \\ &= A'(B' + CD + DE') \\ &= A'[B' + D(C + E')] \\ &= A'(B' + D)(B' + C + E') \end{aligned}$$

$$\begin{aligned} 2.22 \text{ (b)} \quad H'I' + JK \\ &= (H'I' + J)(H'I' + K) \\ &= (H' + J)(I' + J)(H' + K)(I' + K) \end{aligned}$$

$$\begin{aligned} 2.22 \text{ (c)} \quad A'BC + AB'C + CD' \\ &= C(A'B + AB' + D') \\ &= C[(A + B)(A' + B') + D'] \\ &= C(A + B + D')(A' + B' + D') \end{aligned}$$

$$2.23 \text{ (a)} \quad W + U'YV = (W + U')(W + Y)(W + V)$$

$$\begin{aligned} 2.23 \text{ (c)} \quad A'B'C + B'CD' + B'E' &= B'(A'C + CD' + E') \\ &= B'[E' + C(A' + D')] \\ &= B'(E' + C)(E' + A' + D') \end{aligned}$$

2.18 (c) none apply

2.18 (e) product-of-sums

$$2.20 \text{ (a)} \quad F = D[(A' + B')C + AC']$$

$$2.20 \text{ (b)} \quad F = D[(A' + B')C + AC'] = A'CD + B'CD + AC'D$$

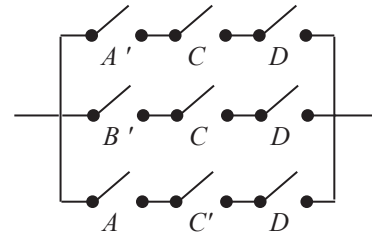

| A | B | C | H | F | G |
|---|---|---|---|---|---|
| 0 | 0 | 0 | 0 | 0 | 0 |
| 0 | 0 | 1 | 1 | 1 | x |
| 0 | 1 | 0 | 1 | 0 | 1 |
| 0 | 1 | 1 | 1 | 1 | x |
| 1 | 0 | 0 | 0 | 0 | 0 |
| 1 | 0 | 1 | 1 | 0 | 1 |
| 1 | 1 | 0 | 0 | 0 | 0 |
| 1 | 1 | 1 | 1 | 1 | x |

$$\begin{aligned} 2.22 \text{ (d)} \quad A'B' + (CD' + E) &= A'B' + (C + E)(D' + E) \\ &= (A'B' + C + E)(A'B' + D' + E) \\ &= (A' + C + E)(B' + C + E) \\ &\quad (A' + D' + E)(B' + D' + E) \end{aligned}$$

$$\begin{aligned} 2.22 \text{ (e)} \quad A'B'C + B'CD' + EF' &= A'B'C + B'CD' + EF' \\ &= B'C(A' + D') + EF' \\ &= (B'C + EF')(A' + D' + EF') \\ &= (B' + E)(B' + F')(C + E)(C + F') \\ &\quad (A' + D' + E)(A' + D' + F') \end{aligned}$$

$$\begin{aligned} 2.22 \text{ (f)} \quad WX'Y + W'X' + W'Y' &= X'(WY + W') + W'Y' \\ &= X'(W' + Y) + W'Y' \\ &= (X' + W')(X' + Y)(W' + Y + W')(W' + Y + Y') \\ &= (X' + W')(X' + Y)(W' + Y) \end{aligned}$$

$$\begin{aligned} 2.23 \text{ (b)} \quad TW + UY' + V \\ &= (T + U + Z)(T + Y' + V)(W + U + V)(W + Y' + V) \end{aligned}$$

$$\begin{aligned} 2.23 \text{ (d)} \quad ABC + ADE' + ABF' &= A(BC + DE' + BF') \\ &= A[DE' + B(C + F')] \\ &= A(DE' + B)(DE' + C + F') \\ &= A(B + D)(B + E)(C + F' + D)(C + F' + E') \end{aligned}$$

Unit 2 Solutions

2.24 (a) $[(XY)'] + (X' + Y)Z = X' + Y + (X' + Y)Z$
 $= X' + Y + Z$ By Elimination Theorem with $X = (X' + Y)$
 $= (X' + Y)$

2.24 (c) $[(A' + B)'] + (A'B'C)' + C'D]'$
 $= (A' + B)A'B'C(C + D) = A'B'C$

2.25 (a) $F(P, Q, R, S)' = [(R' + PQ)S]' = R(P' + Q') + S'$
 $= RP' + RQ' + S'$

2.25 (c) $F(A, B, C, D)' = [A' + B' + ACD]'$
 $= [A' + B' + CD]' = AB(C' + D')$

2.26 (a) $F = [(A' + B)B]C + B = [A' + B + B]C + B$
 $= C + B$

2.26 (c) $H = [W'X'(Y' + Z)']' = W + X + YZ$

2.28 (a) $F = ABC + A'BC + AB'C + ABC'$
 $= BC + AB'C + ABC'$ (By Uniting Theorem)
 $= C(B + AB') + ABC' = C(A + B) + ABC'$
 (By Elimination Theorem)
 $= AC + BC + ABC' = AC + B(C + AC')$
 $= AC + B(A + C) = AC + AB + BC$

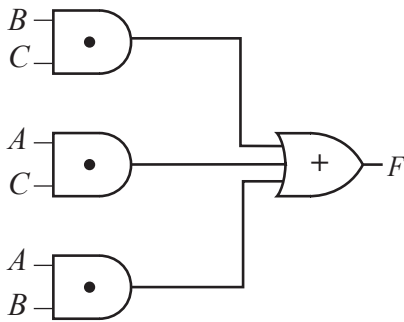

2.29 (a)

| XYZ | $X+Y$ | $X'+Z$ | $(X+Y)$ $(X'+Z)$ | XZ | $X'Y$ | $XZ+X'Y$ |
|-------|-------|--------|---------------------|------|-------|----------|
| 000 | 0 | 1 | 0 | 0 | 0 | 0 |
| 001 | 0 | 1 | 0 | 0 | 0 | 0 |
| 010 | 1 | 1 | 1 | 0 | 1 | 1 |
| 011 | 1 | 1 | 1 | 0 | 1 | 1 |
| 100 | 1 | 0 | 0 | 0 | 0 | 0 |
| 101 | 1 | 1 | 1 | 1 | 0 | 1 |
| 110 | 1 | 0 | 0 | 0 | 0 | 0 |
| 111 | 1 | 1 | 1 | 1 | 0 | 1 |

2.24 (b) $(X + (Y'(Z + W)))' = X'Y'(Z + W)' = X'Y'Z'W'$

2.24 (d) $(A + B)CD + (A + B)' = CD + (A + B)'$
 {By Elimination Theorem with $X = (A + B)$ }
 $= CD + A'B'$

2.25 (b) $F(W, X, Y, Z)' = [X + YZ(W + X)]'$
 $= [X + X'YZ + WYZ]'$
 $= [X + YZ + WYZ]' = [X + YZ]'$
 $= X'Y' + X'Z'$

2.26 (b) $G = [(AB)'(B + C)]'C = (AB + B'C)C = ABC$

2.27 $F = (V + X + W)(V + X + Y)(V + Z)$
 $= (V + X + WY)(V + Z) = V + Z(X + WY)$
 By Distributive Law with $X = V$

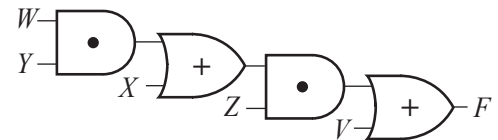

2.28 (b) Beginning with the answer to (a):

$F = A(B + C) + BC$

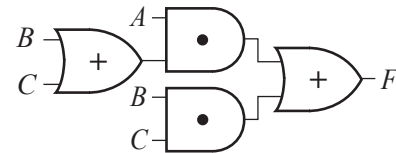

Alternate solutions:

$F = AB + C(A + B)$

$F = AC + B(A + C)$

2.29 (b)

| XYZ | $X+Y$ | $Y+Z$ | $X'+Z$ | $(X+Y)$ $(Y+Z)$ $(X'+Z)$ | $(X+Y)$ $(X'+Z)$ |
|-------|-------|-------|--------|--------------------------------|---------------------|
| 000 | 0 | 0 | 1 | 0 | 0 |
| 001 | 0 | 1 | 1 | 0 | 0 |
| 010 | 1 | 1 | 1 | 1 | 1 |
| 011 | 1 | 1 | 1 | 1 | 1 |
| 100 | 1 | 0 | 0 | 0 | 0 |
| 101 | 1 | 1 | 1 | 1 | 1 |
| 110 | 1 | 1 | 0 | 0 | 0 |
| 111 | 1 | 1 | 1 | 1 | 1 |

Unit 2 Solutions

2-29 (c)

| XYZ | XY | YZ | $X'Z$ | $XY+YZ+X'Z$ | $XY+X'Z$ |
|-------|------|------|-------|-------------|----------|
| 000 | 0 | 0 | 0 | 0 | 0 |
| 001 | 0 | 0 | 1 | 1 | 1 |
| 010 | 0 | 0 | 0 | 0 | 0 |
| 011 | 0 | 1 | 1 | 1 | 1 |
| 100 | 0 | 0 | 0 | 0 | 0 |
| 101 | 0 | 0 | 0 | 0 | 0 |
| 110 | 1 | 0 | 0 | 1 | 1 |
| 111 | 1 | 1 | 0 | 1 | 1 |

2.29 (d)

| ABC | $A+C$ | $AB+C'$ | $(A+C)(AB+C')$ | AB | AC' | $AB+AC'$ |
|-------|-------|---------|----------------|------|-------|----------|
| 000 | 0 | 1 | 0 | 0 | 0 | 0 |
| 001 | 1 | 0 | 0 | 0 | 0 | 0 |
| 010 | 0 | 1 | 0 | 0 | 0 | 0 |
| 011 | 1 | 0 | 0 | 0 | 0 | 0 |
| 100 | 1 | 1 | 1 | 0 | 1 | 1 |
| 101 | 1 | 0 | 0 | 0 | 0 | 0 |
| 110 | 1 | 1 | 1 | 1 | 1 | 1 |
| 111 | 1 | 1 | 1 | 1 | 0 | 1 |

2.29 (e)

| $WXYZ$ | $W'XY$ | WZ | $W'XY+WZ$ | $W'+Z$ | $W+XY$ | $(W'+Z)(W+XY)$ |
|--------|--------|------|-----------|--------|--------|----------------|
| 0000 | 0 | 0 | 0 | 1 | 0 | 0 |
| 0001 | 0 | 0 | 0 | 1 | 0 | 0 |
| 0010 | 0 | 0 | 0 | 1 | 0 | 0 |
| 0011 | 0 | 0 | 0 | 1 | 0 | 0 |
| 0100 | 0 | 0 | 0 | 1 | 0 | 0 |
| 0101 | 0 | 0 | 0 | 1 | 0 | 0 |
| 0110 | 1 | 0 | 1 | 1 | 1 | 1 |
| 0111 | 1 | 0 | 1 | 1 | 1 | 1 |
| 1000 | 0 | 0 | 0 | 0 | 1 | 0 |
| 1001 | 0 | 1 | 1 | 1 | 1 | 1 |
| 1010 | 0 | 0 | 0 | 0 | 1 | 0 |
| 1011 | 0 | 1 | 1 | 1 | 1 | 1 |
| 1100 | 0 | 0 | 0 | 0 | 1 | 0 |
| 1101 | 0 | 1 | 1 | 1 | 1 | 1 |
| 1110 | 0 | 0 | 0 | 0 | 1 | 0 |
| 1111 | 0 | 1 | 1 | 1 | 1 | 1 |

2.30

$$\begin{aligned}
 F &= (X+Y)Z + X'YZ' \\
 &= (X+Y+X'YZ')(Z+X'YZ') \\
 &= (X+Y+X')(X+Y+Y)(X+Y+Z')(Z+X')(Z+Y)(Z+Z') \\
 &= (1+Y')(X+1)(X+Y+Z')(Z+X')(Z+Y)(1) \\
 &= (1)(1)(X+Y+Z')(Z+X')(Z+Y)(1) \\
 &= (X+Y+Z')(Z+X')(Z+Y)
 \end{aligned}$$

(from the circuit)
(Distributive Law)
(Distributive Law)
(Complementation Laws)
(Operations with 0 and 1)
(Operations with 0 and 1)

$$G = (X+Y'+Z')(X'+Z)(Y+Z)$$

(from the circuit)

